

Design and Simulation of Efficient MPPT for a PV System under Rapidly Changing Environmental Conditions

Sanket Sondge¹, Dr. V. B. Virulkar², V. M. Jape³

P.G. Student, Department of Electrical Engineering, GCOE, Amravati, Maharashtra, India¹

Associate Professor, Department of Electrical Engineering, GCOE, Chandrapur, Maharashtra, India²

Associate Professor, Department of Electrical Engineering, GCOE, Amravati, Maharashtra, India³

ABSTRACT: Under rapidly changing environmental conditions conventional MPPT techniques are required to operate fast, a large power loss can be caused by slow tracking speed, output power fluctuation, or additionally required ad hoc parameters. To achieve a fast and efficient MPPT technique that minimizes the power loss with the adaptively binary-weighted step (ABWS) followed by the monotonically decreased step (MDS) without causing output power fluctuation or requiring additional ad hoc parameter is the objective of this work. The simulation results are presented. Unlike the fixed number of iterations in the SAR MPPT using the BWS, the number of iterations for tracking the MPP in the ABWS MPPT algorithm is adaptively adjusted depending on the environmental condition change.

KEYWORDS: Maximum Power Point (MPP), Binary Weighted Step (BWS), Photovoltaic (PV) system.

I. INTRODUCTION

Solar energy is abundant and renewable in nature and can be consider as a future energy source. The need for renewable energy sources is on the rise because of the severe energy crisis in the world today. The major obstacle for the penetration and reach of solar photo-voltaic (PV) systems is their low efficiency and high capital cost. The output voltage of the solar PV panel is highly dependent on solar radiation and panel temperature. The power-voltage and current-voltage relationship of PV system are non-linear in nature. Switched mode DC-DC power converter is the major component in PV system responsible for ensuring maximum power generation.

The maximum power point tracking (MPPT) system controls the voltage and the current output of the PV system to deliver maximum power. Perturb and observe (P & O) technique, incremental conductance technique, fractional short circuit current technique, fractional open circuit voltage technique, ripple correlation control technique, parasitic capacitance technique, intelligent technique and current or voltage feedback technique are few of many available maximum power point tracking (MPPT) methods. A comprehensive review and analysis of around twenty four maximum power point tracking (MPPT) techniques for photovoltaic system available until January 2012 can be found in [1].

Out of most widely used maximum power point tracking (MPPT) techniques, some of them are more popular due to their simplicity, such as the fractional open-circuit voltage technique (V_{frac}), fractional short-circuit current, etc. [2], [3]. However, these techniques suffer from more power loss. Some of the techniques are generalized as they do not depend on the characteristic parameters of the PV module, such as perturb and observe (P&O), incremental conductance, etc. The P&O technique experiences divergence in tracking due to a change in atmospheric conditions and loss of power at steady state on account of oscillations around the MPP [4]–[6]. In the incremental conductance technique, the oscillations can be avoided theoretically as $dP/dV = 0$ at MPP. However, in practice, this condition seldom occurs due to the resolution and uncertainty in the digital acquiring systems [5]–[8]. Also, the selection of the size of

perturbation is crucial in both of the aforementioned techniques as to compromise between the power loss due to oscillations at steady state and the dynamic response [5], [6], [9]–[11]. Moreover, there are techniques which depend on the characteristic parameters of the PV module, and they have to be evaluated offline before implementation, offering good performance [1]. Furthermore, there exists a technique called distributed MPPT technique which allows optimized power extraction under mismatched conditions, claiming good performance [12]. Another MPPT technique for fast tracking based on the binary-weighted step (BWS) is the successive approximation register (SAR) MPPT in [14]. However, the periodic operation between its active and power-down modes inherently makes the output fluctuate even in the absence of a change in environmental conditions. Moreover, the MSB operation runs first in the SAR MPPT, which increasingly aggravates the overall power loss. This paper presents an MPPT algorithm based on the adaptively binary-weighted step (ABWS) and the monotonically decreased step (MDS). This MPPT technique detects the MPP quickly without fluctuation or an additional ad hoc parameter by using LSB first operation, which allows for superior performance compared to others in the tracking and the power loss not only under the steady state (normal operation) but also under the dynamic state (tracking operation). The simulation results are presented.

II. BLOCK DIAGRAM of PHOTOVOLTAIC SYSTEM

The block diagram of MPPT system consists of the solar panel, DC-DC boost converter, load and MPPT controller. The voltage output of solar panel is fed to DC-DC boost converter after which a direct load or battery is connected. The voltage or current from panel are given to the MPPT controller as input then the MPPT algorithm processes these inputs. The MPPT controller is microcontroller or any other embedded platform on which a tracking algorithm is implemented.

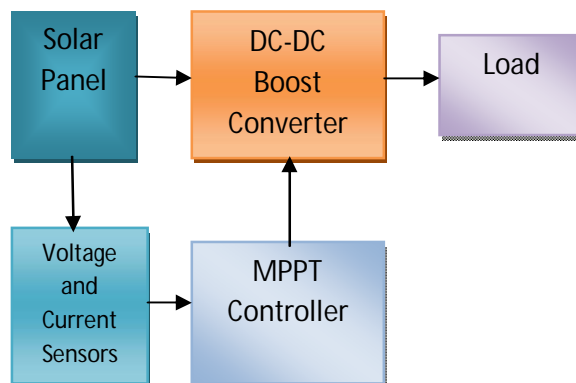

Fig.1. Block diagram of photovoltaic system

Based on the type of algorithm either voltage or current of solar panel or both are sensed. In PO both voltage and current are sensed. DC-DC boost converter act as the variable impedance between the solar panel and load. When the duty cycle of converter is changed the voltage and current of panel changes. The duty cycle of converter is changed as per the MPPT algorithm technique to achieve the MPP of solar panel. Hence the MPPT together with photovoltaic system is a feedback control system where duty cycle of the DC-DC converter is changed to track MPP as per the climate conditions. Fig.1 shows the block diagram of photovoltaic system.

III. MATHEMATICAL MODEL OF THE PV PANEL

The circuit model of a PV module containing N_s number of series-connected cells consists of an ideal current source I_p , a diode, a series resistance R_{se} , and a shunt resistance R_{sh} , whose interconnections are shown in Fig. 2.

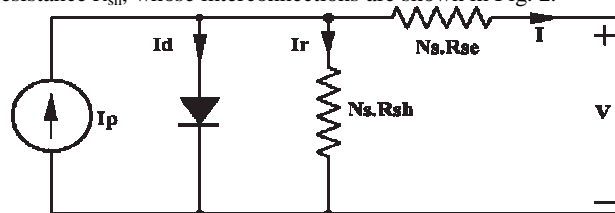

Fig.2. Equivalent circuit model of a PV module having N_s cells in series.

The IV behavior of such model can be represented by a characteristic equation as given in the following:

$$I = I_P - I_{OS} \left\{ \exp \left(\frac{V + IN_s R_{se}}{nN_s V_T} \right) - 1 \right\} - \left(\frac{V + IN_s R_{se}}{N_s R_{sh}} \right) \quad (1)$$

where I_{os} is the reverse saturation current, V_T is the volt equivalent temperature, n is the ideality factor of the PV cell, and V and I are the PV module output voltage and current, respectively.

By taking the first-order derivative of (1) with respect to the PV voltage, we can obtain a relation, given in (2), which shows the rate of change of the PV current in association with the PV voltage

$$\frac{dI}{dV} = - \frac{\frac{I_{os}}{nN_s V_T} \exp \left(\frac{V + IN_s R_{se}}{nN_s V_T} \right) + \frac{1}{N_s R_{sh}}}{1 + \frac{R_{se}}{R_{sh}} + \frac{I_{os} R_{se}}{nV_T} \exp \left(\frac{V + IN_s R_{se}}{nN_s V_T} \right)} \quad (2)$$

The power generated by a PV module depends on the current and voltage relationship. Especially under rapid environmental changing conditions, I_{ph} depends strongly on the irradiance changes and partial shading conditions, which results in a change in power as shown in Fig. 3 shows the decrease in the voltage at the MPP (VMPP) and the open-circuit voltage (V_{OC}) of a PV module as the irradiance is reduced. The values of the irradiance are obtained from the method to extract the California Energy Commission (CEC) weighted efficiency. In Fig. 3 IV characteristic of PV module under various irradiance conditions is shown.

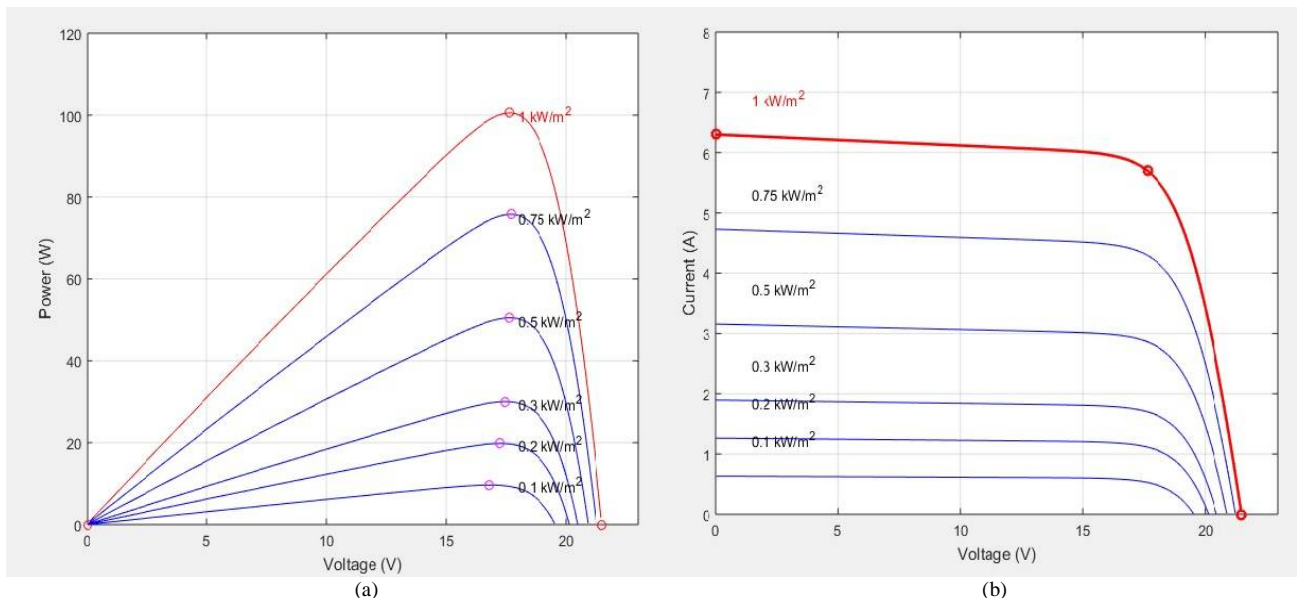

Fig.3. Power versus Voltage (a) and Current versus Voltage (b) characteristics of a PV module under various irradiance conditions.

IV. IMPLEMENTATION OF ABWS AND MDS MPPT ALGORITHM

As discussed earlier, the MPP of a PV module varies according to the environmental conditions. In order to reduce the power loss under rapidly changing environment conditions, this algorithm aims at tracking the MPP as quickly as possible. After tracking the MPP is completed, VMPP remains unchanged as long as the environmental conditions are stable. The proposed MPPT algorithms are based on the ABWS and the MDS, which tracks the MPP quickly without

the aforementioned problems caused by the P&O and the SAR MPPT. Similar to the BWS, the ABWS tracks the MPP by increasing the voltage tracking step in a binary manner but starts from the LSB with the minimum voltage tracking step Δ in Fig. 4. After a certain number of iterations, the operating voltage passes VMPP. Then, the ABWS stops and the MDS deploy to find the exact MPP.

Unlike the fixed number of iterations in the SAR MPPT using the BWS, the number of iterations for tracking the MPP in the proposed MPPT algorithm is adaptively adjusted depending on the environmental condition change. The ABWS passes an internal parameter to the MDS. From the next iteration right after the ABWS, the voltage step is then monotonically reduced until the MPP is found. If the variation of the VMPP drops below 1 LSB resolution, VMPP remains unchanged and the MDS operation is terminated. The proposed MPPT algorithm enhances the tracking speed with less power loss for its fast tracking without output power fluctuation under the stable environmental condition. Additionally, the THD issue in SAR MPPT can be resolved by using the proposed MPPT since the ABWS starts only when the environmental condition changes.

The flowchart of the ABWS and MDS algorithm is depicted in Fig. 4. At the n th iteration, the current " I_n " and the voltage " V_n " of a PV module are sensed to calculate the output power " P_n " of the PV module. The variable "Status" is set to either "Tracking" or the "Steady-state" and indicates if the proposed algorithm tracks or maintains VMPP. The initial value for "Status" is set to "Tracking." The variable "Passing MPP" is set to "Y" after a certain number of the ABWS iterations, which terminates the ABWS operation and activates the MDS operation sequentially after the MPP is passed. The variables "m" and "D" represent the exponent for the voltage step increment and the direction of VMPP, respectively. The variable "Whichway" is used for checking the correct direction of VMPP in each iteration, the initial values of variables are " $P_{Max} = 0$ ", " $P_{n-1} = 0$ ", " $V_{n-1} = 0$ ", " $m = 0$ ", and " $D = 1$ ".

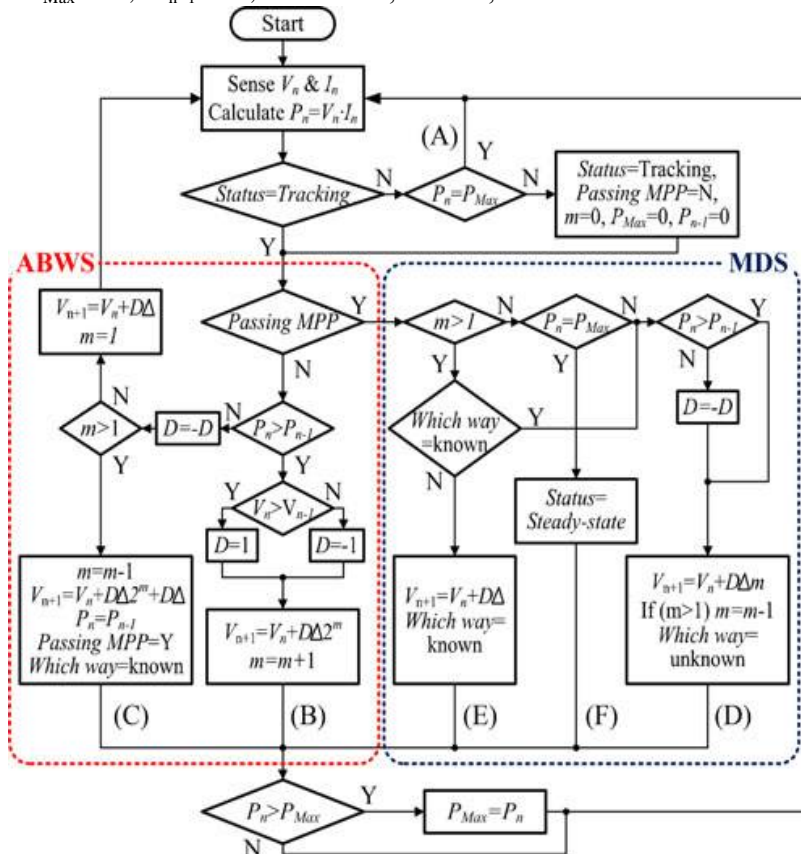

Fig. 4. Flowchart for ABWS and MDS Algorithm.

V. SIMULATION RESULTS

The specification of a PV module JSM100-36-01 that consists of 36 cells in series, used for simulation are $V_{MPP}=17.64$ V and $I_{MPP}=5.70$ A, under standard testing conditions (1000 W/m² and 25 °C). Fig. 5 shows the MATLAB Simulink model of MPPT for a PV module. As it is difficult to control the irradiance rapidly for outdoor testing, it is done in simulation by using Signal Builder, the experiment evaluates the tracking time for the initial setup and the 20% irradiance drop as shown in Fig. 6. Fig. 7 shows the operating voltage of the PV module in the time domain while changing the irradiance from 1000 to 800 W/m². The MPP tracking of the P&O, the MAHC, and the VSSINC MPPT takes more iterations for the initial setup compared with the tracking time of the ABWS and MDS MPPT, resulting in more power loss due to low tracking speed and fluctuation around MPP. Even though the tracking time of the SAR MPPT is faster than that of the ABWS and MDS MPPT, a large amount of power loss is introduced by the SAR MPPT due to the tracking allowed only in the active mode. Note that the active and power-down modes in the SAR MPPT are periodically repeated every 44 iterations in the simulation. For the situation where the change of the irradiance from 1000 to 800 W/m², the tracking time of all algorithms are comparable with each other except for the SAR MPPT that takes longer.

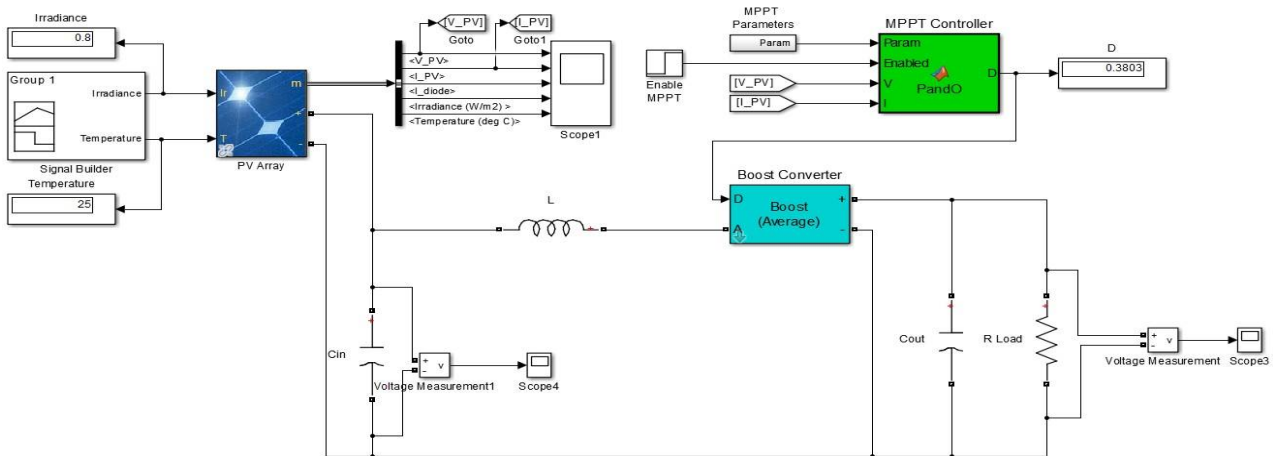

Fig. 5. MATLAB Simulink model of MPPT for a PV module

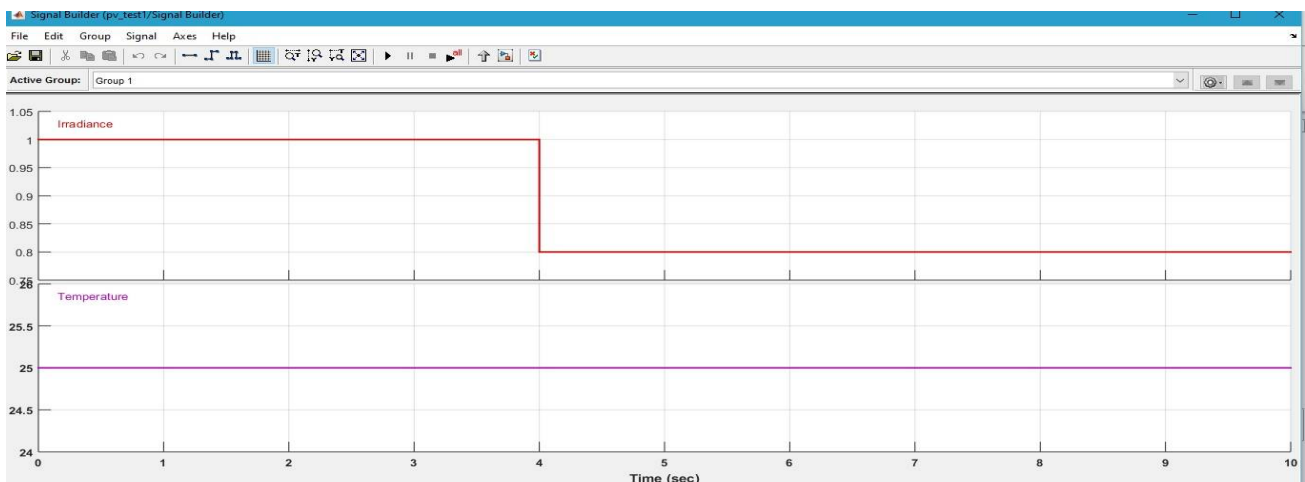

Fig. 6. Input irradiance and temperature for a PV module.

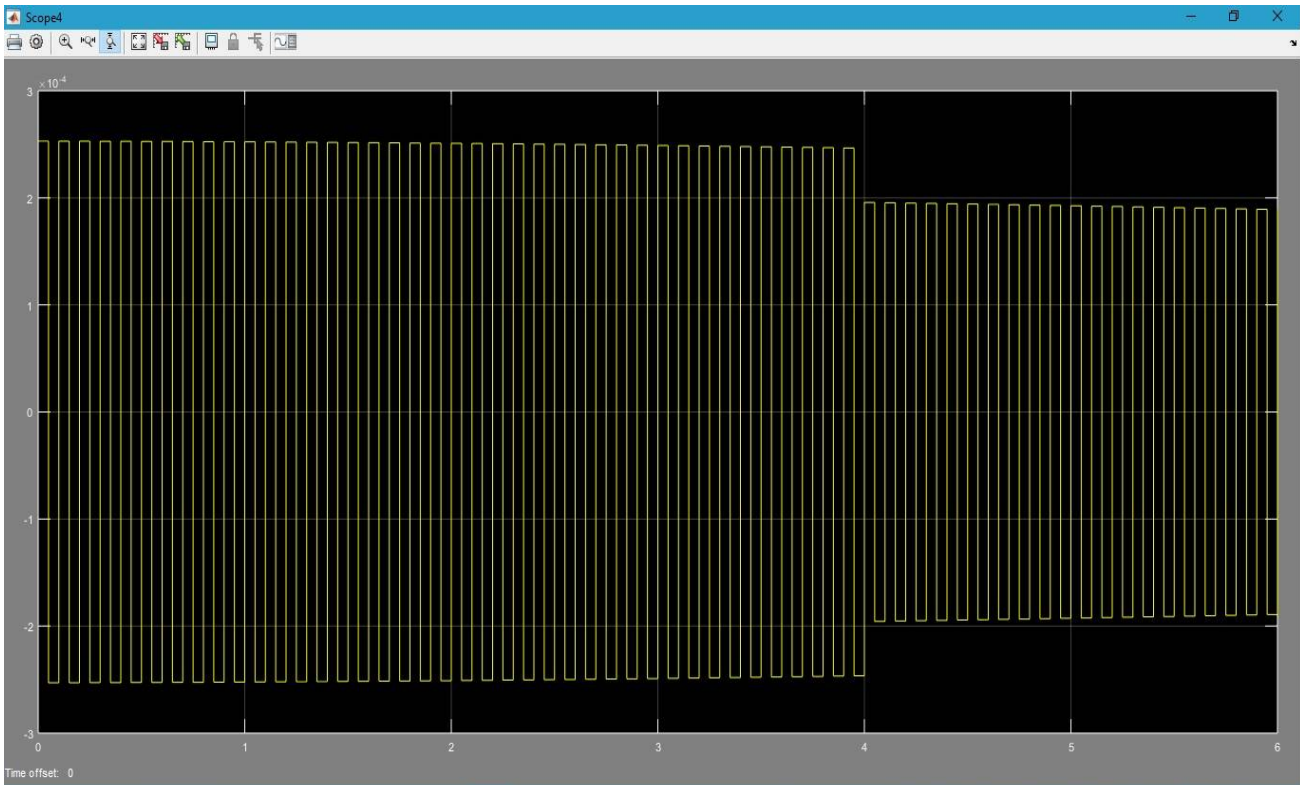

Fig. 7. Operating Voltage of PV module when Irradiance drops by 20%

VI. CONCLUSION

This paper presented an MPPT technique for aPV system, in order to track the MPP quickly without fluctuation. The ABWS and theMDS MPPT techniques minimize the power loss under rapidly changing environmental conditions without an additional *ad hoc* parameter. Even though the proposed MPPT system is implemented by using a boost converter, it can also be applied to any type of DC-DC converter. The theoretical analysis and the simulation results validate that the proposed MPPT is superior to others in regard to the tracking time and the overall power loss not only under normal conditions but also under rapidly changing environmental conditions.

REFERENCES

- [1] B. Subudhi, and R. Pradhan, "A comparative study on maximum power point tracking techniques for photovoltaic power systems," IEEE Transactions on Sustainable Energy, vol. 4, no. 1, pp. 89-98, January 2013.
- [2] O. López-Lapeña, M. T. Penella, and M. Gasulla, "A closed-loop maximum power point tracker for subwatt photovoltaic panels," IEEE Trans. Ind. Electron., vol. 59, no. 3, pp. 1588-1596, Mar. 2012.
- [3] M. A. S. Masoum, H. Dehbonei, and E. F. Fuchs, "Theoretical and experimental analyses of photovoltaic systems with voltage and current-based maximum power-point tracking," IEEE Trans. Energy Convers., vol. 17, no. 4, pp. 514-522, Dec. 2002.
- [4] A. M. Latham, R. Pilawa-Podgurski, K. M. Odame, and C. R. Sullivan, "Analysis and optimization of maximum power point tracking algorithms in the presence of noise," IEEE Trans. Power Electron., vol. 28, no. 7, pp. 3479-3494, Jul. 2013.
- [5] F. Liu, S. Duan, F. Liu, B. Liu, and Y. Kang, "A variable step size INC MPPT method for PV systems," IEEE Trans. Ind. Electron., vol. 55, no. 7, pp. 2622-2628, Jul. 2008.
- [6] N. Femia, G. Petrone, G. Spagnuolo, and M. Vitelli, "Optimization of perturb and observe maximum power point tracking method," IEEE Trans. Power Electron., vol. 20, no. 4, pp. 963-973, Jul. 2005.
- [7] M. A. Elgendy, B. Zahawi, and D. J. Atkinson, "Assessment of the incremental conductance maximum power point tracking algorithm," IEEE Trans. Sustain. Energy, vol. 4, no. 1, pp. 108-117, Jan. 2013.

International Journal of Innovative Research in Science, Engineering and Technology

An ISO 3297: 2007 Certified Organization

Volume 6, Special Issue 1, January 2017

International Conference on Recent Trends in Engineering and Science (ICRTES 2017)

20th-21st January 2017

Organized by

Research Development Cell, Government College of Engineering, Jalagon (M. S), India

- [8] M. A. Gomes de Brito, L. Galotto, Jr., L. P. Sampaio, G. de Azevedo e Melo, and C. A. Canesin, "Evaluation of the main MPPT techniques for photovoltaic applications," *IEEE Trans. Ind. Electron.*, vol. 60, no. 3, pp. 1156–1167, Mar. 2013.
- [9] A. Safari and S. Mekhilef, "Simulation and hardware implementation of incremental conductance MPPT with direct control method using Cuk converter," *IEEE Trans. Ind. Electron.*, vol. 58, no. 4, pp. 1154–1161, Apr. 2011.
- [10] E. Bianconi, J. Calvente, R. Giral, E. Mamarelis, G. Petrone, C. A. Ramos-Paja, G. Spagnuolo, and M. Vitelli, "A fast current-based MPPT technique employing sliding mode control," *IEEE Trans. Ind. Electron.*, vol. 60, no. 3, pp. 1168–1178, Mar. 2013.
- [11] Q. Mei, M. Shan, L. Liu, and J. M. Guerrero, "A novel improved variable step-size incremental-resistance MPPT method for PV systems," *IEEE Trans. Ind. Electron.*, vol. 58, no. 6, pp. 2427–2434, Jun. 2011.
- [12] V. V. R. Scarpa, S. Buso, and G. Spiazzi, "Low-complexity MPPT technique exploiting the PV module MPP locus characterization," *IEEE Trans. Ind. Electron.*, vol. 56, no. 5, pp. 1531–1538, May 2009.
- [13] G. Petrone, G. Spagnuolo, and M. Vitelli, "An analog technique for distributed MPPT PV applications," *IEEE Trans. Ind. Electron.*, vol. 59, no. 12, pp. 4713–4722, Dec. 2012.
- [14] H.-K. Kim, S.-J. Kim, C.-K. Kwon, Y.-J. Min, C.-W. Kim, and S.-W. Kim, "An energy-efficient fast maximum power point tracking circuit in an 800-uW photovoltaic energy harvester," *IEEE Trans. Power Electron.*, vol. 28, no. 6, pp. 2927–2935, Jun. 2013.